

Safeguarding Land, Sea and Air Space



CII EXIM Bank Business
Excellence Award Winner
& Role Model Organisation



BHARAT ELECTRONICS LIMITED

राष्ट्र के रक्षा बलों को सशक्त बनाते हुए
Empowering the Nation's Defence Forces

ABOUT US

Guided by a farsighted vision to make the country self-reliant in Defence electronics, Bharat Electronics Limited (BEL) was set up in Bengaluru in 1954 by the Government of India under the Ministry of Defence (MoD). BEL is today a Navratna Public Sector Undertaking and India's foremost Defence electronics company.

BEL is a multi-product, multi-technology, multi-Unit conglomerate which designs, develops & manufactures state-of-the-art products and systems for the Defence forces in the areas of Radars, Missile Systems, Military Communications, Naval Systems, Electronic Warfare & Avionics, C4I Systems, Electro Optics, Tank Electronics & Gun/Weapon System Upgrades, Strategic Components, etc. In the non-Defence business segment, BEL is into areas such as Homeland Security & Smart Cities, Solar, Satellite Integration & Space Electronics, Transportation Solutions (Railways/Metro, AAI, etc), Artificial Intelligence, Cyber Security, Software as a Service, Energy Storage Products and Electronic Voting Machines (EVMs), besides Composite Shelters & Masts

Bharat Electronics Ltd.

Showing the way for
'Make in India'



"BEL will strive to achieve its cherished goals of self reliance by strongly supporting & implementing Govt's initiative on 'Make In India' and thereby giving further boost to the Indian Industry."

CMD, BEL



Signing of Joint Venture Agreement between BEL and Safran Electronics and Defense, to establish a JVC for production of HAMMER Smart Precision Guided Air-to-Ground Weapon in India.



Make in India Display Cells have been established at all Units of BEL.

Collaborative R&D

Partner empanelment status

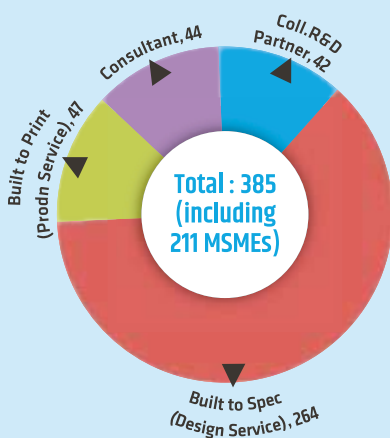

BEL'S TURNOVER IN THE LAST 5 YEARS (In Rs Crores)

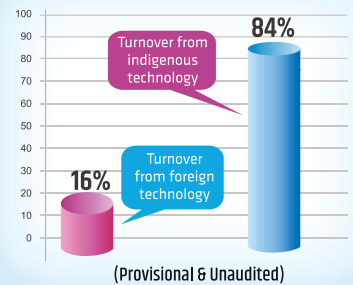
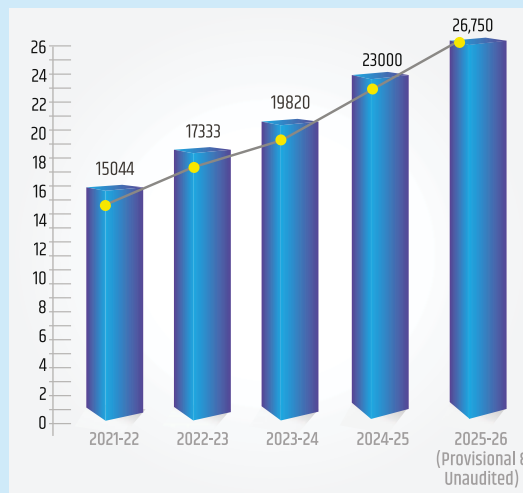

For more details, visit bel-india.in and refer the exclusive page on 'Make in India'

BEL Units

Regional Offices

- New Delhi
- Mumbai
- Kolkata
- Visakhapatnam

Marketing Offices

- Bengaluru
- New Delhi

Overseas Offices

- Vietnam
- ASEAN

Subsidiary & JVs

BEL Optronic Devices Ltd
 Manufactures Night Vision
 Image intensifier Tubes

GE-BE Private Limited
 Manufactures CT Max,
 state-of-the-art
 X-Ray tubes and Detectors,
 Image intensifier Tubes

BEL Thales Systems Limited
 Design, development
 & supply of civilian and
 select Defence Radars
 for Indian and global markets



Vision

To be a World-class
 Enterprise in
 Professional
 Electronics

Mission

To be a customer-focussed,
 globally competitive
 company in Defence
 Electronics and in other
 chosen areas of Professional
 Electronics, through Quality,
 Technology and
 Innovation

Values

- Putting customers first
- Working with transparency, honesty & integrity
- Trusting & respecting individuals
- Fostering team work
- Striving to achieve high employee satisfaction
- Encouraging flexibility and innovation
- Endeavoring to fulfill social responsibilities
- Proud of being a part of the organisation

Business Segments

Radars

Network Centric Systems (C4ISR)

Missile Systems

Naval Systems

Defence Communications

Electro Optics

Homeland Security & Smart Cities

Tank Electronics & Gun Upgrades

Electronic Warfare & Avionics

Non-Defence Products

Radars

- Country's prime Radar production house with modern facilities at Bangalore and Ghaziabad
- 80% of Radars from BEL are indigenously developed
- More than 300 Radars (Surveillance, Navigation, Fire control, Air Traffic Management & Weather forecasting) supplied in the last 5 years



Aslesha

Low Level Light-Weight, 3D Surveillance Radar having solid state transmitter and receiver with capability to detect formations of aircraft in horizontal and vertical planes

LYNX Series

LYNX series of Naval Gun Fire Control Systems are Quick Reaction, Multi Sensor (Radar/EO), Multiple Weapon Fire Control Systems for short/medium/long range panoramic defence of ships against air/surface/shore targets.



Weapon Locating Radar

Weapon Locating Radar (WLR) locates hostile guns, mortars and rockets impeding armed forces' operations. In its secondary role, the radar tracks and observes the fall of shot from own weapons to provide corrections to the fire.

Other Capabilities in Radars

- Central Acquisition Radar
- 3D Tactical Control Radar
- Low Level Light Weight Radar
- Low Level Transportable Radar
- Troop Level Radar
- Flight Level Radar
- Weapon Locating Radar
- Naval Gun Fire Control System
- L-band Early Warning Naval Radar
- Identification of Friend or Foe Mk XII & Variants
- 3D Naval Air Surveillance Radar
- Surface Surveillance Radar
- Coastal Surveillance Radar
- AESA Radar for SAM Systems
- Air Defence Fire Control Radar
- Air Defence Tactical Control Radar
- 3D E/F Naval Missile Defence Radar
- 3D Multi Target Tracking Radar
- Doppler Weather Radar
- Long Range High Power Surveillance Radar
- Medium Power Radar
- Low Level Light Weight Radar Mk II
- Battle Field Surveillance Radar

Missile Systems



Akash Missile System

- Akash is a Medium Range, Surface-to-Air Missile System to protect against air threats
- Akash is a great success story of 'Make In India' initiative with almost 95% material sourced from within the country



3D-Central Acquisition Radar



Flight Level Radar



Missile Launcher



Flight Control Centre

QRSAM Weapon System

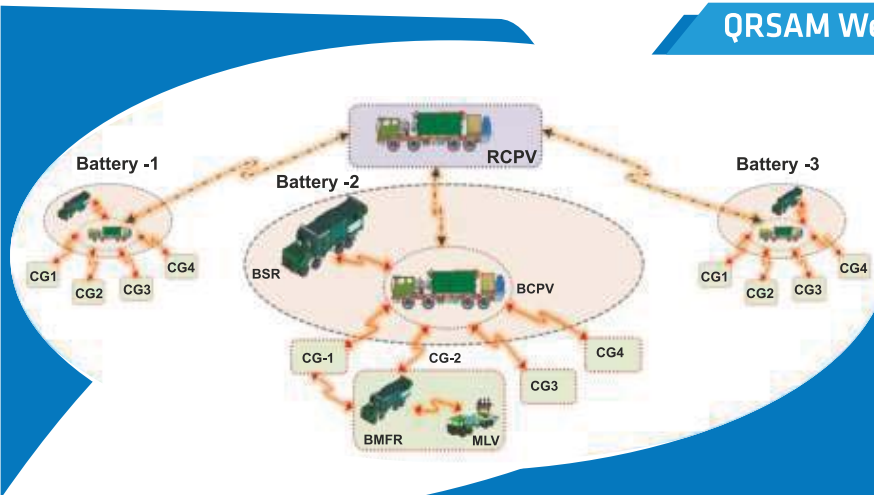

- Under development in collaboration with DRDO
- Meant for providing air defence coverage for moving mechanised combat forces
- Capable of Search, Detection and Tracking of air threats on the move with firing capability on halt

Other Technological Capabilities

- RF Seekers for various missiles like Akash 1S, Akash NG and QRSAM
- Satellite On the Move (SOTM)
- Radio on the Move (ROTM)
- Two Way Data Links
- Combat Management System for MRSAM
- Onboard Processor for Missile
- Zinc Sulphide (Zns) domes for IR Seekers
- IFF System for MRSAM

Missile Systems Capabilities

- Long Range Surface-to-Air Missile System (LRSAM)
- Medium Range Surface-to-Air Missile System (MRSAM)
- PECHORA digitisation for IAF and global customers
- Akash 1S (With Seekers)
- Akash -New Generation

Defence Communications

- Since its inception, BEL has been supplying secure communication radio products to the Indian Defence and Paramilitary forces in all frequency bands like VLF, HF, VHF, UHF and other higher bands
- BEL's latest range of military radios includes Software Defined Radio, Point to Multi-Point Radio, High Data Rate Radio Relays and Secure Smart Phone

Software Defined Radios

- Multiband, multirole radio capable of operating from 30Mhz to 2 Ghz
- Backward compatible and inter-operable with legacy radios
- Capable of High Data rates and frequency hopping
- Various form factors and platforms for all three Services



SDR – Naval Communication



SDR – Manpack



SDR-Airborne



SDR – Handheld

Other Communication Products



Radio On The Move



STARS V Mk III



Combat Net Radio



Versatile Link and IP Encryptor



Secure Smart Phone

GSAT Terminals



Satcom Messaging Terminal



Handheld Satcom Terminal



Mobile Satellite Service - Manpack Terminal Mk-IV

Strategic Communication Systems

- Advanced Composite Communication System
- Digital Mobile Radio Relay
- Secure Cellular Mobile Network
- Troposcatter Communication System
- Cyber security solution for C4I system and network
- VoIP based communication and switching system

Homeland Security & Smart Cities

Integrated Border Management System



- A new vertical has been formed in 2017 to focus on Homeland Security, Smart Cities & Surveillance projects leveraging BEL's strengths
- Some of the Homeland Security and Smart City projects of BEL are Integrated Perimeter Security Systems for Indian Air Force, Naval Airfield Integrated Security Systems for Navy, Integrated Traffic Management System, Agra Smart City, Belagavi Smart City, etc.

Electronic Warfare & Avionics

- BEL is the leading EW&A production house meeting the Indian Defence Forces' requirements for land, naval and airborne EW systems, in partnership with DRDO
- A number of EW systems including Radar Warning Receivers have been supplied for aircraft and helicopters (MiG 29, Jaguar and LCA)
- The EW systems have now been upgraded to EW suites for aircraft and self-protection suites for helicopters

Airborne EW Systems



Land/Naval Based EW Systems



Reconnaissance & Direction Finding System



GCS & Datalink Deployment for Rustom UAV



RCIED Jammer

Avionics Products-LCA (Tejas)



Other Systems Capabilities

- Radar Warning Receivers
- Missile Warning System
- Ground Based Mobile ELINT System
- Low Intensity Conflict Electronic System
- RCIED Jammers
- Shipborne Radar ESM & EW Suite
- Integrated Radar Satcom & Elint for Submarines (IRSAES)
- SIGINT Suite (ELINT & COMINT)
- Communication Antenna for Tethered Submarine Communication Buoy
- ESM for Submarines
- Compact Multipurpose Stabilisation System (CoMPASS)



CoMPASS

- Shipborne COMINT • Airborne Jammer
- EW Suite for fighter aircraft (MiG 29, JAG, LCA)
- Light weight self protection suite for helicopter
- Advanced Shipborne EW System
- Integrated EW System for mountainous terrains
- Ground Control Station and Data Link for UAVs
- Payload for UAV/Aerostat
- Airborne Tactical Datalinks
- Mini / Micro UAVs
- Instrumented Electronic Warfare Range (IEWR)
- Airborne ESM for small Aircraft & Helicopters
- Airborne COMINT for small Aircraft & Helicopters

Network Centric Systems (C4ISR)

- The need to network and provide a Digital Battle Space for geographically dispersed forces has resulted in BEL developing various C4I solutions for the armed forces

Combat Management System for Navy

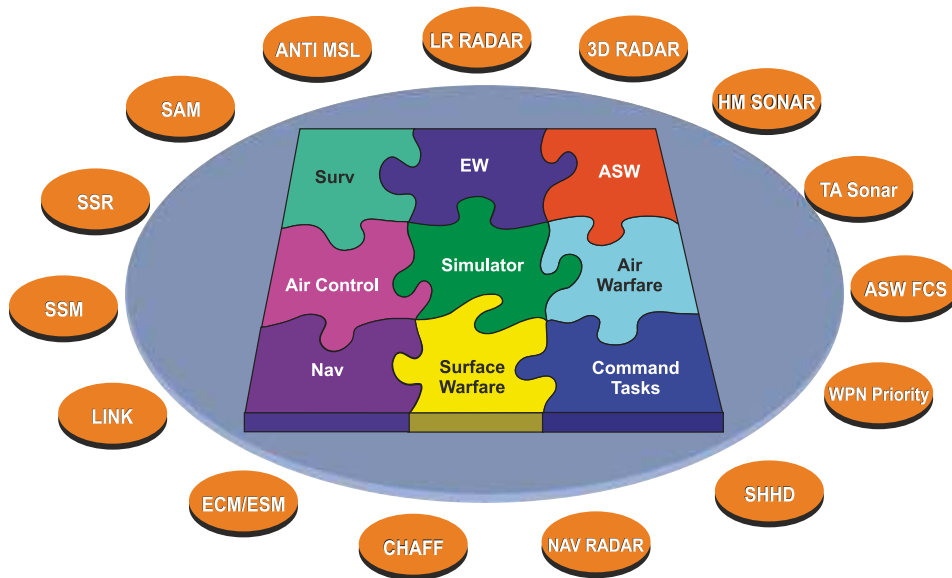

NC³I (NATIONAL COMMAND CONTROL AND COMMUNICATION INTELLIGENCE) NETWORK



FEATURES

1. Terrestrial and VSAT connectivity across 43 mainland stations and VSAT connectivity for 8 island stations.
2. Voice & Video connectivity across 51 stations through Tele Presence, Video Conference and Video IP Phones
3. Disaster Recovery Station at Vizag for Information Management and Analysis Centre (IMAC) redundancy
4. World Class Data Wall Room for 24x7 Surveillance and Analysis

Other Network Centric Systems Capabilities

Army

- Artillery Combat Command & Control System (ACCCS)
- Tactical Communication System (TCS)
- Battlefield Surveillance System (BSS)
- Battlefield Management System (BMS)
- Command Information and Decision Support System (CIDSS)
- Air Defence Control & Reporting System (ADC&RS)

Navy

- Combat Management System (CMS)
- Combat Information System
- Navigation Complex System for Submarines

Air Force

- C4I System
- Operational Data Link
- Air Early Warning and Control System (AEWCS)

Naval Systems

- Exclusive Strategic Business Units to develop various Naval Systems
- BEL provides Indian Navy with indigenously developed solutions for Defence against sub-surface, surface and air threats Coastal Surveillance System



Costal Surveillance System

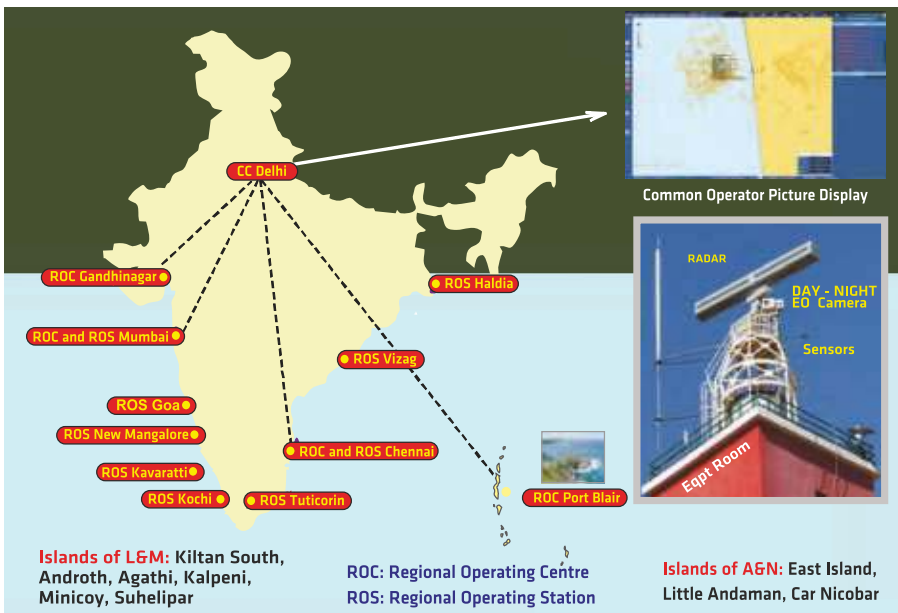

LRSAM

- BEL is the lead integrator of Long Range Surface-to-Air Missile (LRSAM) System for the Navy's P-17A stealth frigates
 - The system is capable of simultaneously tracking multiple seaborne targets
- Systems Developed / Under Development



Other Systems Capabilities

- Naval Radars
- Electronic Warfare Systems
- Gun Fire Control Systems
- Underwater Submarine Detection/Tracking systems
- Ship Navigation systems
- Ship Data Network
- Shipborne SAM Systems
- Ship Voice/Data Communication systems (VLF, HF, VHF, VSAT, SDR-NC, GMDSS)
- Sonar and Advanced Torpedo Defence System with Counter Measures including Decoys
- Combat Management System with integrated Weapons & Sensors for Central Command & Control

Electro Optics

- Cooled & Uncooled Thermal Imager for Long & Medium Range Surveillance Systems, Coastal Surveillance System and Tank Sights
- State-of-the-art Passive Night Vision Devices with Auto-gated XD4 and XR5 technologies
- Laser based EO systems for ranging & target designation



Passive Night Vision Binocular



Passive Night Vision Goggles



Hand-Held Thermal Imager with LRF



Long Range Reconnaissance & Observation System - PRAHARI



Passive Night Sight For Rocket Launcher



Multi Purpose Weapon Sight (For Carbine & Assault Rifle)



Uncooled Thermal Sight For Assault Rifle



Multi-purpose Reflex Weapon Sight- TRINETRA



Light Weight Portable Laser Target Designator



Laser Range Finder Eye Safe



Gap Measuring Device

Other Capabilities

- Passive Night Vision Devices
- Hand Held Thermal Imager (Cooled & Uncooled)
- Uncooled Thermal Imager Sights for Small Arms like AK-47, INSAS Rifle, INSAS LMG
- Hand Held Thermal Imager with Laser Range Finder
- EOS for Integrated Coastal Surveillance System
- Long Range Reconnaissance & Observation System
- Commander TI Sight for T-90 / T-72 / BMP Tanks
- Driver Night Sight for Arjun & T-90 Tanks
- Gunner's Main Sight
- Hand Held Target Acquisition System
- Uncooled TI Sight for Sniper Weapons
- Border Surveillance System (BOSS)
- Active Range Gating Camera (ARGC)



XR5 Image Intensifier Tube

BEL OPTRONIC DEVICES LIMITED

A subsidiary company for manufacturing XD4 and XR5 Image Intensifier (II) Tubes and Power Supply Units used in Night Vision Devices

Tank Electronics & Gun Upgrades

- BEL has been providing state-of-the-art system solutions for the upgrade of Tanks and Guns

Upgraded L-70 Gun

- State-of-the-art Fire Control Computer
- Electra Optical Fire Control System
- Day and night vision with Automatic Target Tracking
- State-of-the-art All Electric Drive
- BITE facility
- Interface to Radars (Fire Control & Tactical)
- Onboard battery for 10 hours operation; backup for additional 12 hours operation



Remote Controlled Weapon Station



- An improvised version of the manually operated air defence gun
- Enables the soldier to aim and fire at aerial targets from the safe interiors of the battle tank
- Can also be mounted on hovercraft/fast moving boats for the Coast Guard
- Remote Firing option
- Automatic Cocking
- DSP Based Brushless Drive Technology
- 2 Axis Self-stabilised platform
- Day Camera & Night Vision
- Automated FCS & Ballistics corrections
- Automatic Target Tracking

Tank Electronics Subsystems

- TI Commander Sight / Gunners Sight / Drivers Sight
- Combat Net Radio
- Advanced Land Navigation System (ALNS)
- Integrated Fire Detection & Suppression System
- Digital Inter Communication System for AFVs
- Laser Warning System
- Futuristic Infantry Combat Vehicle (FICV) solutions

Other Technological Capabilities

- L-70 Gun Upgrade
- Schilka Weapon System Upgrade
- Tank Intercom System
- All Electric Drives
- Land Navigation System
- High Accuracy Pointing System for Guns
- Stabilised Optronic Pedestal
- Remote Controlled Weapon Station
- Electronic Systems for 155 mm Indigenous Gun variants
- Electrical and Electronic Systems for Multi Barrel Rocket Launcher
- Advanced Gunners' main site
- Close-in Weapons System

Other Areas

Electronic Fuzes

BEL has established a state-of-the-art manufacturing set-up at its Pune Unit to meet this requirement of the Indian Army. The Unit has till date supplied 2,00,000 Fuzes to the Indian Army



Percussion Fuze



Time Fuze



Proximity Fuze

Unmanned Systems

Tethered UAV based Electro Optic Surveillance System



Missile Seekers

BEL has manufactured Ku Band indigenous RF Seekers for the Astra, QRSAM and Akash-1S missile programmes with technical guidance from RCI



Composites

BEL has established a state-of-the-art manufacturing facility for Composite Materials, Environmental Testing & Finishing at its Navi Mumbai Unit. The facility is being used to carry out inhouse designing and manufacturing of components using GFRP and CFRP Composites for various Naval applications, submarines, aircraft and shelters



GRPF Composite Shelter



Pressurised Missile Container

Smart City

BEL is one of the leading Smart City Solution providers in India implementing several Smart Cities as part of the Smart City mission of the Government of India



Software

BEL Software Technology Centre (BSTC), a CMMI Level 5 organisation, is a software business hub of BEL. BSTC offers software development and software assurance services for both domestic and export market. BSTC is CERT-empanelled as an IT Security organisation comprising VAPT and Security compliance audits. The software centre has also got Design House approval from CEMILAC (Centre for Military Airworthiness & Certification) for performing IV&V



Software Products /Modules

- Attendance and Access Control Software
- Video Management and Video Analytics
- Smart City Platform
- BEL Public Key Infrastructure solution (BESafe)
- GIS for Military Applications
- Network Management System
- Combat Management System Monitoring and Control
- STARS Visualizer for Defence
- Debrief Display
- Weapon / Ballistics Control Modules
- Threat Computation Modules
- Message Analyzer
- Element Management in Adverse Network (EMAN)
- Planning of Radio Frequency in Adverse Situation (PORAS)
- Generic Radar Vext Display System

ADVERSARY NETWORK ANALYSIS TOOL (ANANT)



AI Based Solutions

- Adversary Network Analysis Tool (ANANT)
- Face Recognition System

Software Services

- Independent Verification & Validation for Software
- Vulnerability Assessment & Penetration Testing
- IT Security Audits based on ISO 27001
- Software Quality Assurance
- Custom Software Development

Custom Application Software Development

FACE RECOGNITION SYSTEM



Non -Defence Products

- Turnover from Non-Defence business is around 15%
- Introduced newly designed secure & tamper proof Electronic Voting Machine and Voter Verifiable Paper Audit Trail (VVPAT) for the Election Commission of India
- Designed and supplied Tablet PCs for Socio Economic Caste Census (Ministry of Rural Development)
- Designed and successfully commissioned Doppler Weather Radar for meteorological applications
- Home Land Security & Smart City Solutions



Electronic Voting Machine



VVPAT



Micro ATM



Doppler Weather Radar

Solar



320 W PV module

- State-of-the-art manufacturing facility for mono crystalline solar cells based on 156x156 mm wafers with an efficiency of 18.9%
- Solar Module Plants for manufacturing modules up to 320 W with an efficiency of 16%
- Setting up Megawatt scale solar plants on Developer/EPC mode

SATELLITE INTEGRATION & SPACE ELECTRONICS

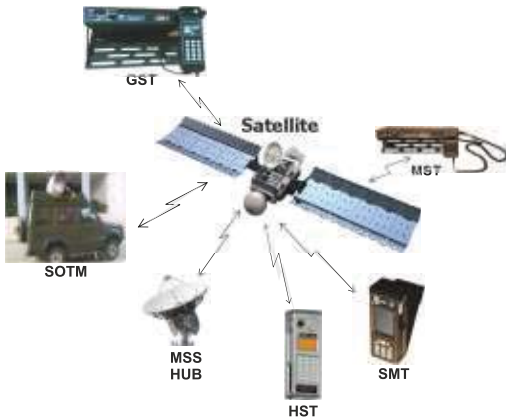

With assistance of ISRO, the BEL team completed Satellite Integration & Testing of the recently launched all-weather Imaging Satellite, RISAT-2B. BEL has plans to establish an exclusive facility for Satellite Integration in Bengaluru

RAILWAYS

SWAGAT: One of the major projects BEL has taken up in the Railways segment is the Automatic Fare Collection Gating System (SWAGAT) to support the Government of India's National Common Mobility Card (NCMC). SWAGAT, developed in collaboration with CDAC to support the One Nation One Card project, operates across all modes of transport and is a huge step towards Digital India

Communication Based Train Control (CBTC): Communications-based Train Control is a railway signalling system that makes use of the telecommunications between the train and track equipment for traffic management and infrastructure control. With CBTC, the exact position of a train can be known more accurately

Real-time Train Information System (RTIS): RTIS provides real-time train information to the Indian Railways to increase the operational efficiency of Indian Railways along with enhancing passenger safety. It provides real time positional information of locomotives to the Indian Railways

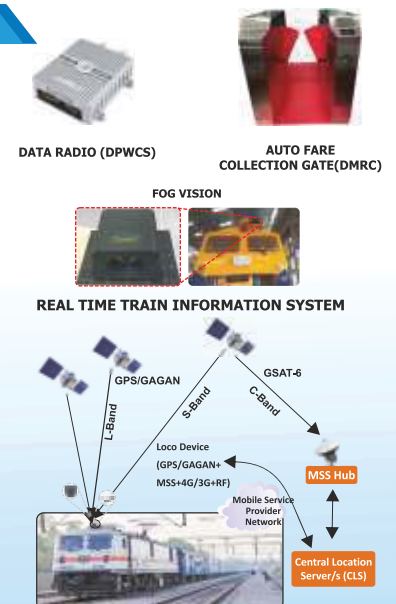

Exports

- Dedicated Business Development & Marketing Group for Exports
- Close interactions with various foreign Aerospace and Defence companies to offer Offset manufacturing services
- Eleven SBU/Units certified for International Aerospace Standard (AS 9100) to meet Offset requirements
- Focus on 'Build to Print', 'Build to Spec' and 'Engineering & Design services'
- Contract Manufacturing and turnkey solutions being offered
- Strategic alliances with global OEMs (Elbit, IAI, Thales, SAAB) for joint development/co-production
- Focus on meeting the requirements of South East Asian countries for Communication products, Sonars, Fire Control System, Coastal Surveillance System and CoMPASS
- Customised Electronic Voting Machine being offered to South East Asian, Middle East and African countries

Major Products/Systems /Solutions Exported

Ship Communication System, Coastal Surveillance System, Electronic Warfare Systems, Identification of Friend or Foe System, Electro Optical Fire Control System, Hull Mounted Sonar, Radar Finger Printing System, Radar Warning Receiver, L Band Surveillance Radar, Tank Fire Control System, Airborne Electro Optic System (CoMPASS), Electronic Voting Machines.

Major Customers



Research & Development

- 96% of Sales revenue from indigenous R&D
- 50% of engineers in BEL are in R&D
- BEL spends about 9% of its turnover on R&D every year
- American Society for Quality (ASQ) Reliability certification for engineers
- Patents for inhouse innovations
- Software Division certified for CMMi Level 5
- Consistently winning Raksha Mantri awards for Design, Innovation and Indigenisation
- Collaborative R&D Initiatives with Startups, Academia & MSME5

3 - Tier R&D Structure with more than 2000 Engineers and 30 R&D Centres

Central Research Labs (Bangalore & Ghaziabad)

- Blue Sky Research - Futuristic Technologies (Photonics, Cognitive Radios & Radars, Sensor Data Fusion, Networking Waveforms, Cyber Security & Artificial Intelligence)

Product Development & Innovation Centre

- Core Technology Development for Ongoing Projects
- Product Development (Defence Software, Encryption, RF & Microwave, Radar Signal Processing & Missile Solutions)

Development & Engineering Groups at Each Unit

- Development & Engineering of Products & Systems

R&D Infrastructure

- R&D Labs are equipped with PCB Design, Simulation, Environmental Testing, latest design software tools, special test instruments and dedicated CADD Centre
- Rapid Prototyping
- Dedicated Software Technology Centre
- Central Research Laboratories at Bangalore and Ghaziabad
- Quality Assurance and Reliability Labs
- Facilities for Documentation and Technical Literature
- Product Development & Innovation Centre

Quality

- CII Exim Bank Excellence Award & Role Model Organisation
- Six Sigma, PMP, CRE, CQE
- CMMi Level 5 Certification
- 7 SBUs / Units Certified for AS 9100 (Aerospace Standards)
- All SBUs / Units Certified for 15014001- 2004, ISO 9001-2008,
- QMS & EMS Standards
- Shop Floor Level (QCC, QIT, Suggestion Scheme)

QA Facilities

- Rapid Prototype
- Reliability Analysis
- EMI / EMC
- Near Field Antenna Test Range
- Temperature Cycling & Humidity
- Thermal Shock
- Salt Spray
- Walk In Chamber
- Metrology Calibration
- Near Field Antenna Test Range

Expansion & Modernisation

Major investments made for infrastructure expansion and modernisation in recent years to meet emerging business needs



Supercomponents Facility
 For manufacturing high performance Radio Frequency (RF) & Microwave (MW) components



Near Field Antenna Test Range (NFTR) Facility
 For Testing and Calibration of Active Array Radar Antenna



Missile System Integration Facility
 State-of-the-art facility for testing & integration of various sub-systems of Missile Systems



Accoustic Test Facility
 For Testing of Transducers/Hydrophones required for Sonar/ Underwater Systems

Future Expansion Plans

- Advanced Night Vision Products Factory
- Defence System Integration Complex
- Underwater Transducer Manufacturing & Testing Facility
- Facility for Radar & Antenna Integration
- Test facility for T72 Hydraulic System
- Modern Electro Optics manufacturing facility
- Satellite Integration facility
- Ammunition Manufacturing Plant
- Unmanned Systems Manufacturing Facility

Product Support Network



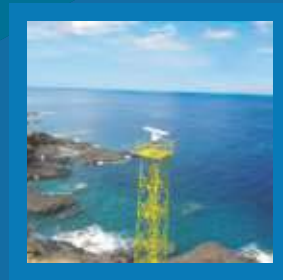
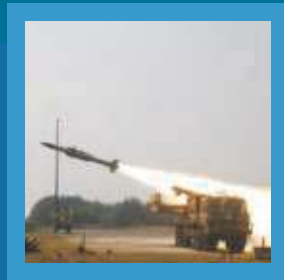
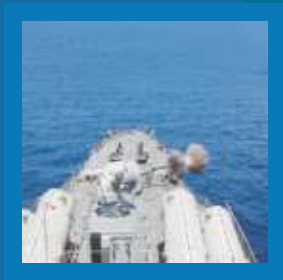

 **भारत इलेक्ट्रॉनिक्स**
BHARAT ELECTRONICS
QUALITY, TECHNOLOGY, INNOVATION

BHARAT ELECTRONICS LIMITED

(A Govt. of India Enterprise under the Ministry of Defence)

e-mail: imd@bel.co.in
www.bel-india.in